

Saprate

BEFORE THE HON'BLE UTTAR PRADESH ELECTRICITY REGULATORY
COMMISSION, LUCKNOW

PETITION NO. 1752 of 2021

IN THE MATTER OF:

Alaknanda Hydro Power Company Ltd. - Petitioner

Versus

Uttar Pradesh Power Corporation Ltd. - Respondent

AND

IN THE MATTER OF:

Rama Shanker Awasthi ... Impleader

INDEX

S. No.	Particulars	Page Nos.
1.	Additional Affidavit on behalf of the Impleaded Respondent, Mr. Rama Shanker Awasthi.	1 - 4
2.	Annexure A A copy of the CDM-MR Report of the Petitioner's Project	5 - 24
3.	IB	25

Filed by

Rama Shanker Awasthi
(Impleaded Respondent)

Date: 16/02/22

Place: Lucknow

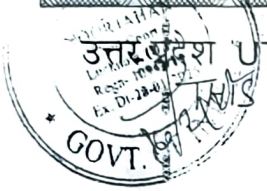
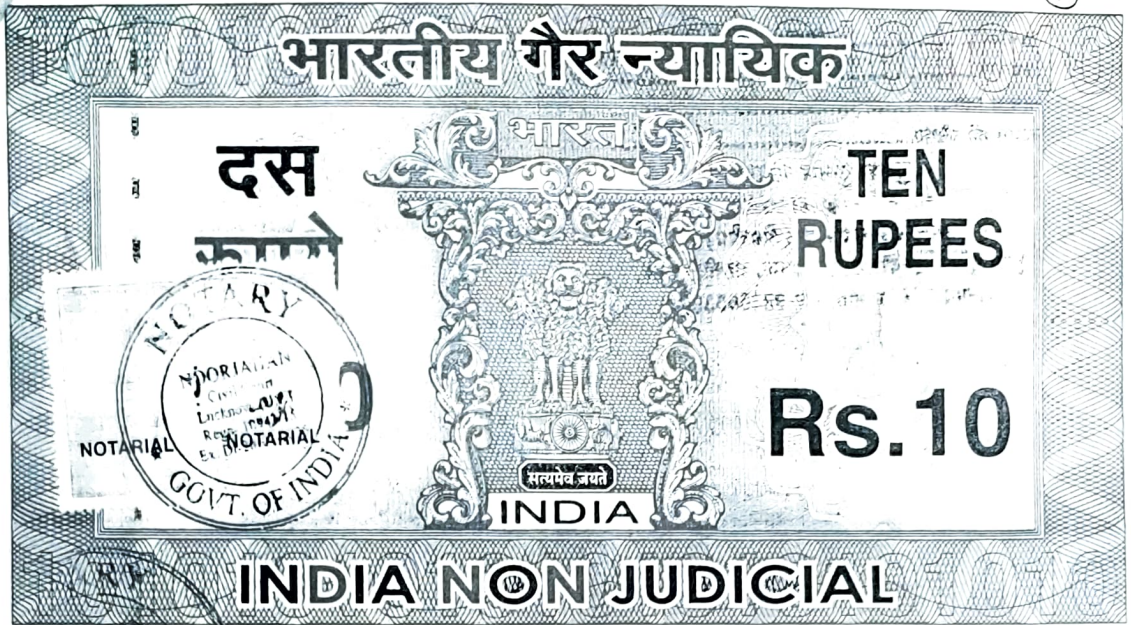

UTTAR PRADESH 51AE 122622
STAMP PAPER IS PART OF AFFIDAVIT ENERGED HEREWITH
PETITION NO. 1752 OF 2021

IN THE MATTER OF:-

Alaknanda Hydro Power Company Ltd. Petitioner
VERSUS
Uttar Pradesh Power Corporation Ltd. ... Respondent

and Verified
before me. AND
Rama Shanker Awasthi

... Impleader

NOORJAHAN
Advocate & Notary
Civil Court, Lucknow
Registration No. 0943/15

RH Awasthi

BEFORE THE HON'BLE UTTAR PRADESH ELECTRICITY REGULATORY COMMISSION, LUCKNOW

PETITION NO. 1752 of 2021

IN THE MATTER OF:

Alaknanda Hydro Power Company Ltd. - Petitioner
Versus
Uttar Pradesh Power Corporation Ltd. - Respondent

AND

IN THE MATTER OF:

Rama Shanker Awasthi ... Impleader

ADDITONAL AFFIDAVIT ON BEHALF OF THE IMPEADED RESPONDENT, RAMA SHANKER AWASTHI, TO THE CAPTIONED PETITION

I, Rama Shankar Awasthi, S/o Late Sh. Gaya Prasad Awasthi, aged about 48 years, Hindu by religion, residing at 301, Surabhi Deluxe Apartment, 6/7 Dalibagh, Lucknow-226001, the deponent hereby annexing my ID-proof and do hereby solemnly affirm and state on oath as under:-

- 1. I say that I am the Consumer Representative.
2. It is submitted that the captioned petition has been filed by Alaknanda Hydro Power Company Limited ("AHPCL"/ "Petitioner") seeking a true-up of the tariff for the FY 2014-15 to FY 2018-19. The Petitioner is supplying power to the State of Uttar Pradesh from its 330 MW (4 X 82.5 MW) Hydro Electric Project situated in Shrinagar ("Project"), in terms of the Amended and Restated Power Purchase Agreement dated 28.06.2006 ("PPA").
3. It is submitted that during the hearing held on 01.02.2022, the Hon'ble Commission had directed the Impleader herein to file his objections at the earliest. Accordingly, the Impleaded Respondent has filed the Objections dated 10.02.2022 to the captioned petition.

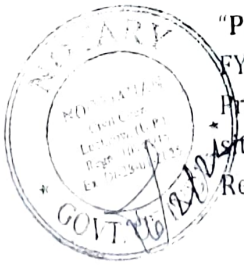

Handwritten signature of Rama Shanker Awasthi.

4. It is submitted that while perusing the submissions of the petitioner, there is another issue that has come to light, which has so far skipped the attention of the parties. Accordingly, the Impleaded Respondent is constrained to raise the said issue through the instant Additional Affidavit. It is humbly requested that the instant Additional Affidavit be read as part of the Objections dated 10.02.2022.
5. It is submitted that Regulation 2(3) of the UPERC Generation tariff regulations, 2014 and 2019, provides as follows:
"(3) The generating company may adopt Clean Development Mechanism, for generating stations approved and commissioned on or after 1.4.2014, and the proceeds of carbon credit from approved CDM project shall be shared in the following manner, namely
(a) 100% of the gross proceeds on account of CDM to be retained by the project developer in the first year after the date of commercial operation of the generating station;
(b) In the second year, the share of the beneficiaries shall be 10% which shall be progressively increased by 10% every year till it reaches 50%, where after the proceeds shall be shared in equal proportion, by the generating company and the beneficiaries."
6. As such, it is submitted that all proceeds of the Carbon Credit from the Approved CDM Project, which in this case if the Petitioner's Project, be shared between the Petitioner and UPPCL, who is the beneficiary of the Petitioner's Project. It is noteworthy that the COD of the Project has been held to be as 21.06.2015, and the Plant had been functioning for atleast around 4 years during the period that is subject of the captioned petition.
7. Notably, as per the information available publicly, the Petitioner has, from the period from 01.01.2013 to 31.12.2020, has achieved emission reductions amounting to 1,112,512 tCO₂e. In terms of the extant regulatory regime, the petitioner is entitled to receive 1 CER (certified emission reduction certificate) for reduction of each 1 tonne of carbon emissions. This means that the Petitioner would have received around 11,12,512 CERs for the aforementioned period. These CERs are traded, whose price fluctuates in open market from 10 USD to 35 USD.
A copy of the CDM-MR-Form of the Project is annexed herewith and marked as **Annexure A**.
8. It is submitted that however the submissions and documents placed on record by the petitioner do not provide any details of the CDM benefit accrued to the petitioner and how much of it has been



R. H. Aravind

shared with the beneficiary, UPPCL. It is clear that the petitioner is bound to share these benefits, in terms of this Hon'ble Commission's regulations. Accordingly, the Hon'ble Commission may direct the Petitioner to clarify the same on record, for the benefit of the Hon'ble Commission while carrying out the exercise of True-up in the captioned Petition.

- 9. I say that the contents of the Reply/ Objections are based on the records and information available in the public domain and the records maintained by me and the legal advice available to the me and, as such, are believed to be true by me.
- 10. I say that the annexure attached to the instant affidavit herein is a true-copy of its original.

R. Shanker
Deponent

Lucknow

Dated: 16/2/22

VERIFICATION

I, the deponent named above, do hereby verify that the contents of the affidavit are true to the best of my own knowledge, and are believed by me to be true on the basis of records kept by me and the legal advice available to me. No part of it is false and nothing material has been concealed in it, so help me God.



Lucknow

Dated: 16/2/22

R. Shanker
Deponent

I identify the deponent on the basis of records which the deponent produced before me and who has signed this affidavit after understanding its contents.

~~S. J. Iqbal Advocate~~
Reg. No. 6043/1999
Advocate

Sworn and Verified before me.

NOTARY
Solemnly affirmed before me on 16/2/22 at 4:00 a.m./p.m. by Sri Rama Shanker Awasthi, the deponent who is identified by Sri *S. J. Iqbal*
Advocate.

NOOR JAHAN
Advocate & Notary
Reg. No. 100

I have satisfied myself by examining the deponent that he understands the contents of this affidavit which have been read out and explained by me.

ANNEXURE - A

5

CDM-MR-FORM

	Monitoring report form for CDM project activity (Version 08.0)		
MONITORING REPORT			
Title of the project activity	Run-of-the-river Hydroelectric Power Project in Uttarakhand by Alaknanda Hydro Power Company Limited.		
UNFCCC reference number of the project activity	4776 ¹		
Version number of the PDD applicable to this monitoring report	6		
Version number of this monitoring report	01		
Completion date of this monitoring report	28/04/2021		
Monitoring period number	05		
Duration of this monitoring period	01/02/2020 to 31/12/2020 (inclusive of both the dates)		
Monitoring report number for this monitoring period	01		
Project participants	M/s Alaknanda Hydro Power Company Limited		
Host Party	India		
Applied methodologies and standardized baselines	ACM0002 ver. 12.1.0 - Consolidated baseline methodology for grid-connected electricity generation from renewable sources. ² Standardized baselines: Not Applicable		
Sectoral scopes	1 - Energy industries (renewable - / non-renewable sources)		
Amount of GHG emission reductions or net anthropogenic GHG removals achieved by the project activity in this monitoring period	Amount achieved before 1 January 2013	Amount achieved from 1 January 2013 until 31 December 2020	Amount achieved from 1 January 2021
	0 tCO ₂ e	1,112,512 tCO ₂ e	0 tCO ₂ e
Amount of GHG emission reductions or net anthropogenic GHG removals estimated ex ante for this monitoring period in the PDD	1,104,935 tCO ₂ e		

¹ <https://cdm.unfccc.int/Projects/DB/BVQI1304680909.79/view>

² <https://cdm.unfccc.int/methodologies/DB/C505BVV9P8VSNV3LTK1BP3OR24Y5L>



RM

SECTION A. Description of project activity

A.1. General description of project activity

Alaknanda Hydro Power Company Limited (AHPCL) is setting up a 330 MW 'run of the river' hydropower project in Uttarakhand. The 330 MW Shrinagar Hydro Electric Project is located on Alaknanda River, a major tributary of the Ganga River, a perennial river in Uttarakhand. The project site is 110 km from Rishikesh railhead, along Rishikesh - Badrinath highway. A weir has been proposed on Alaknanda River at Shrinagar, about 26 km downstream of Rudraprayag for generation of hydroelectricity. The power project is already started commercial operation in year 2015. The project proponent does not own or operate any other renewable energy project.

Pre-project Scenario:

This being a Greenfield project, no power generation facility existed at the project site in the pre project scenario. Taking in to account its impact after the project becomes operational; the pre-project scenario can be generation of equivalent amount of electricity in the grid using the existing fuel mix. This will also mean continuing a short fall of significant electricity leading to frequent load shedding.

Purpose of the project activity:

The purpose of the project activity is construction and operation of a grid connected renewable electricity generation hydroelectric power plant. The project activity will reduce the GHG emission by use of a clean, renewable (hydro power) source for power generation in place of common fossil fuels. The project activity will reduce the dependence on fossil fuel of the North (new Integrated Northern, Eastern, Western and North Eastern—NEWNE) grid which is dominated by emission intensive coal based thermal power plants. The project activity involves construction of a concrete gravity diversion weir across the river Alaknanda, and its left bank construction stage diversion tunnel, an intake on right bank consisting of 6 numbers intake tunnels joining two Head Race Tunnels (HRT) through a manifold section, of 9.8 m dia. circular head race tunnel followed by a RCC cut and cover conduit crossing the supana nallah, a desilting basin followed by power channel, fore bay, power house, tail race channel and switchyard. The powerhouse would accommodate 4 generating units of 82.5 MW each. The proposed civil structures of Shrinagar Hydro-Electric Project have been planned and designed to divert and convey maximum design discharge of 560 m³/s.

The project activity is evacuating the power generated from the project activity into four feeders at 400 KV at Srinagar, Vishnuprayag and Muzzfarnagar.

During the current monitoring period i.e. from 01/02/2020 to 31/12/2020 the project has resulted in emission reductions of 1,112,512 tCO₂e and underwent continued operation except scheduled breakdowns.

A.2. Location of project activity

The project activity is located in Tehri Garhwal and Pauri Garhwal Districts in Uttarakhand, India. The Alaknanda River, on which the project has been proposed, rises in the glacier regions of the Greater Himalayas in the extreme northern part of the border district of Chamoli in Uttarakhand. The Alaknanda is joined by the Mandakini River at Rudraprayag. The length of Alaknanda up to Rudraprayag is 180 km with an average slope of 24.0 m per km. The Mandakini River runs for a length of 80.0 km up to the confluence at Rudraprayag with an average slope of 42.0 m per km.

A weir has been proposed on Alaknanda River at Shrinagar, about 26 km downstream of Rudraprayag for generation of hydro-electricity. The project site is located on the river Alaknanda at a distance of about 110 km from Rishikesh railhead, along Rishikesh - Badrinath highway. This location is towards north east of Pauri and towards Rudra Prayag.



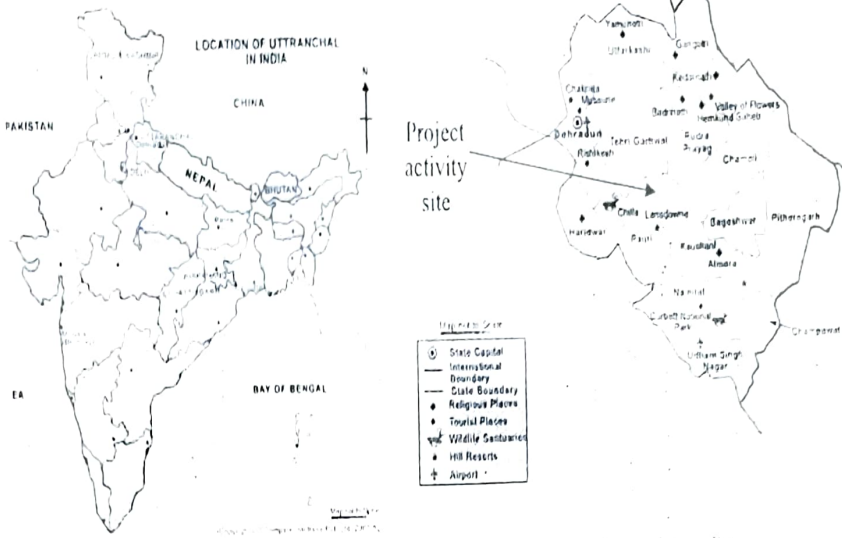

Figure 1: Location of Uttarakhand state in India and location of the site.

State, District, Tehsil	Uttarakhand, Tehri Garhwal and Pauri Garhwal, Kirtinagar & Pauri
Longitude	78° 50' 01" E
Latitude	30° 14' 20" N
Nearest rail head	Rishikesh
Nearest Airport	Dehradun
Nearest National Highway	NH -58

A.3. Parties and project participants

Parties involved	Project participants	Indicate if the Party involved wishes to be considered as project participant (Yes/No)
India (host)	Alaknanda Hydro Power Company Limited, Hyderabad (Private Entity)	No

A.4. References to applied methodologies and standardized baselines

Methodology: ACM0002 Version 12.1.0 "Consolidated baseline methodology for grid-connected electricity generation from renewable sources"

Tools:

- "Tool for the Demonstration and assessment of additionality", Version 05.2
- "Tool to calculate the emission factor for an electricity system" Version 02
- "Tool to calculate project or leakage CO₂ emissions from fossil fuel combustion", Version 02

A.5. Crediting period type and duration

Type of crediting period	Fixed
Crediting period from	15/03/2013 to 14/03/2023 (Fixed)
Length of the Crediting Period	10 Years
Current Monitoring period from	01/02/2020 to 31/12/2020 (inclusive of both days)
Length of the Monitoring Period	335 Days



SECTION B. Implementation of project activity

B.1. Description of implemented project activity

The project activity is construction and operation of 330 MW hydroelectric power plant to supply electricity to the grid. The project activity being a Greenfield project, no power generation facility existed in the pre-project scenario. The project proponent does not own or operate any other renewable energy project. The service provided by the project activity is the generation of electricity to the tune of 330 MW. In the absence of the project activity the equivalent power would have been generated from the existing fuel mix in the grid and the future capacity additions.

The major milestones relevant to project activity implementation are as follows:

1. PPA signed and DPR completed in 2000
2. Techno Economic Clearance obtained from Central Electricity Authority in 2000
3. Quotation received for Civil and Mechanical works in 2004
4. Board Resolution to implement the project activity 13/11/2005
5. Letter of intent issued for construction work 26/04/2006
6. Implementation agreement between Alaknanda Hydro, Govt of Uttarakhand and Govt. of Uttar Pradesh signed on 10/02/2006
7. Implementation work started on 26/04/2006
8. Commissioning of the project done on 23/04/2015, 21/06/2015, 02/05/2015 & 21/06/2015

The main elements of the concerned project activity are:

Weir and Spillway:

A 90 m high diversion weir with spillway crest elevation at 584.50 m has been proposed to have a live storage of 8.00 mcm between Full Reservoir Level (FRL) of 605.50 m and Minimum Draw Down level (MDDL) of 603.00 m. The weir at the top would be 248 m long comprising 140 m over flow section and 108 m non-over flow section. The spillway located in the middle of the weir would have 8 radial gates of sizes 14 m (width) x 21.15 m (height).

Intake Structure:

The intake structure has been located on the right bank about 100 m upstream of the weir axis and about 12 m inside from the line with the spillway on the right side. The intake works have been planned and designed for taking in 660 m³/s at the MDDL i.e. EL 603 m. Tunnel type intake structures having 6 openings are proposed to provide 132 m³/s discharge through each individual 6.5 dia. tunnels which join two numbers 9.80 m diameter HRTs.

Head Race Tunnel (HRT):

The main HRTs would be 2 numbers of about 1100 m long with 9.80 m dia. each.

Supana nallah crossing:

Beyond HRTs, 2 RCC conduits have been provided for a length of about 185 m.

Desilting Basin:

A desilting basin of size 157 m (width) * 200 m (length) * 29 (depth) is provided at the end of RCC into two compartments by providing a RCC wall in between.

Power Channel:

The 3.20 km long Power Channel takes off immediately from the desilting basin and terminates into fore bay at the end of its run. The channel would be trapezoidal section in general and would vary depending on the land available and would be provided with cement concrete lining in its entire length.

Fore bay:

The power channel would terminate in a fore bay structure. The width of the fore bay structure (48 m) of the fore bay is designed to accommodate the total width of the intake structure at the upstream side of the penstocks.



By Pass Channel:

A bypass channel to discharge the surplus water, in case of sudden stoppage of units is provided for a length of about 297 m long and would discharge directly into the river. The crest of the structure is kept at EL 596.8 m and would comprise 3 bays of 15 m width with 2 piers each of 1.5 m thick.

Intake Structure:

The intake structure located at the end of fore bay accommodates 4 penstocks and is spaced at 20 m centre to centre. Bell mouth entry with suitable transitions has been provided at the entry leading to the 5.6 m dia. penstocks. The center line of the penstock at the intake has been kept at EL 593 m.

Penstocks:

4 numbers steel penstocks of 5.6 dia. have been provided to lead the discharge from the fore bay to the power house. The penstocks are spaced 20 m center to center.

Power House and Switchyard:

The size of power house structure is 52.40 m (width) x 131.50 m (length) and would house 4 numbers Francis Turbines (vertical shaft) generating 82.5 MW each. The turbine would operate under a varying maximum head of 68.00 m to minimum head of 63.00m. The runner dia. of inlet /outlet are 4022/3984.4000 mm respectively. The bottom removal facility for quick maintenance has been provided. The turbines would be fed by individual penstocks from the fore bay and controlled by electro-hydraulic modern type governors.

Switchyard have four 400 kV outgoing transmission line bays.

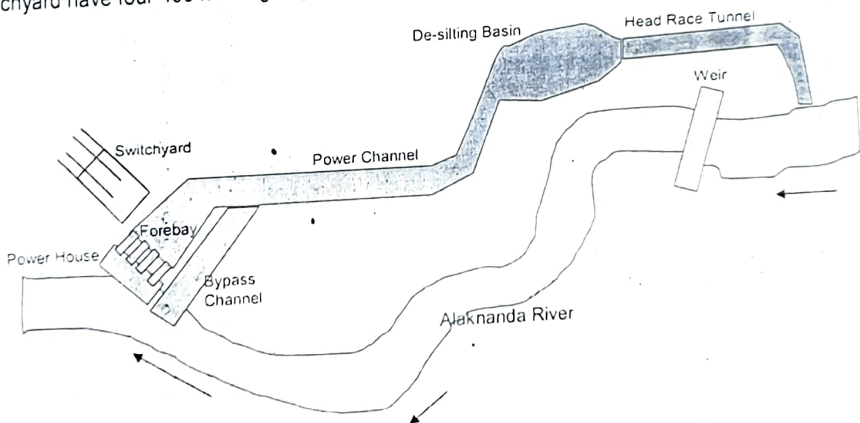

Figure 2: Systematic representation of project activity.

A brief description of the turbine (total 4 No's) parameters is given below.

Parameter	Value
Make	BHEL
Rated Power	82.5 MW * 4
Average lifetime	35 years
Efficiency	93.36%

Turbine Head Range
 Normal: 65.0 m
 Maximum: 68.0 m
 Minimum: 63.0 m



CDM-MR-FORM

Considering modern practices for designing of Francis Turbines, particularly in view of susceptibility to erosion of turbine parts due to silt in river water, the essential turbine parts such as runners, guide vanes, facing plates, labyrinth rings shall be coated with a resistance layer of hard ceramic material embedded in a ductile matrix. Each turbine would be fed by individual penstocks from fore bay and controlled by Electro-hydraulic modern type governors. The Runners, Labyrinth seals, Guide vanes are envisaged to be of stainless steel to minimize erosion. Runners and Guide vanes shall be 13/4 Chrome Nickel steel.

Each of the four turbines have rated capacity 82.5 MW with 10% continuous overloading and maximum output of 92.95 MW.

The generator is proposed to be a vertical shaft synchronous machine with rated continuous output of 97.06 MVA, having rotational rated speed of 166.66 rpm and run away speed of 315 rpm to match with that of turbine. A brief description of the generator parameters is given below

Generator:

Parameter	Value
Make	BHEL
Rated power	82.5 MW * 4
Average lifetime	30 years
Efficiency	98%
Rated Voltage	13.8 kV, Range $\pm 10\%$
Frequency	50 Hz +3% to -5%
Excitation	Static type
Power Factor	Rated PF (lagging) – 0.85



111

CDM-MR-FORM

The generators' continuous overload output is 90.75 MW. The generator stator and rotor windings are provided with epoxy insulation of class 'F'. The generator ventilation system would be of closed recirculation type with air cooled by water. The generator shall be designed to withstand the runaway speed which shall be co-ordinated with the turbine supplier.

The bearing arrangement comprise a turbine guide bearing and a thrust cum guide bearing below the generator rotor. This bearing arrangement is recommended in view of comparatively low speed of rotation. Generation of power at 13.8 kV is stepped up to 400 kV by a power transformer. The arrangement for Power Evacuation from Shrinagar Hydro Power Station is as below:

1. One circuit of 400 kV Muzaffarnagar-Vishnuprayag line may be made with line in and line out (LILO) at the Switchyard of Shrinagar Power House.
2. One double circuit connected from Srinagar Power House substation to PTCUL substation at Shrinagar.

Based on the estimated generation, the PLF is calculated to be at 52.3% for the project activity. This is the overall load factor of the entire plant and the individual units contribute accordingly. The lifetime of the project activity is estimated as 35 years.

Mass and Energy balance:

The capacity of the concerned project activity is designed based on the hydrological studies conducted by the Central Water Commission (CWC) in the Alaknanda River. The hydrological series of 23 years total unrestricted energy generation is arranged in a descending order and then the 90% of the hydrological year is found out by formula $(0.9 \times (N+1))$ th year where N is the number of years for which the data is available.

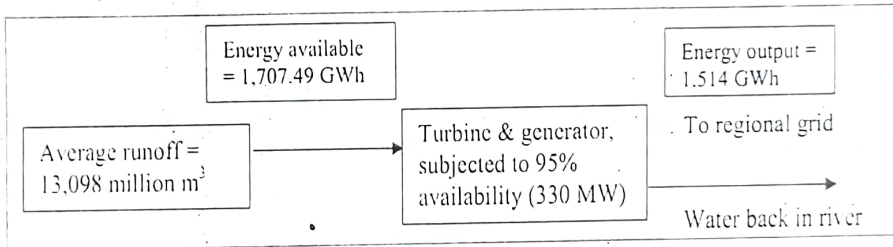

The level of service provided by the project activity is not dependant on any other manufacturing system outside the project boundary. The power generation depends only on the flow rate of the water in the river. As the project activity is constructed based on the historic flow a condition, the mass balance is not envisaged to be subjected to major changes.

The project activity utilizes hydro power for generation of electricity. The technology consists of conversion of the potential energy available in the water flow to mechanical energy using a hydro turbine and by connecting to a generator, mechanical energy is converted into electrical energy. In this process there is no burning of any fossil fuels and hence no emissions. Thus electricity is generated through sustainable means without causing any negative effect on the environment. Therefore the technology is environmentally safe and sound. The use of this advanced technology to harness the renewable energy source avoids emission of GHGs and other pollutants like CO, SOx, NOx and SPM commonly associated with power generation in general.

Technology transfer from Annex I countries is not involved in the project activity.



As per the applicable methodology, as the project activity is the installation of a new grid-connected renewable power plant/unit, the baseline scenario is - electricity delivered to the grid by the project activity would have otherwise been generated by the operation of grid-connected power plants and by the addition of new generation sources, as reflected in the combined margin. The emission sources and gases included are none for the project activity (as per the applicable methodology - no CO₂ emissions from hydroelectric power plants and CO₂ emissions from the current fuel mix in the grid in the baseline.

B.2. Post-registration changes

B.2.1. Temporary deviations from the registered monitoring plan, applied methodologies, standardized baselines or other methodological regulatory documents

There is no request for deviation applied during this monitoring period.

B.2.2. Corrections

Following PRC-Correction changes applied for the project:

1. The status of commissioning of project activity is updated being commissioned in Year 2015
2. The contact details of focal point are changed in Appendix 1 of the revised PDD version 06 dated 30/10/2020.
3. The correction in estimated emission reduction values due to change in combined margin emission factor in section B.6.3 and B.6.4 of PDD. The Correction in calculation of grid emission factor by considering 3 years generation weighted average OM emission factor. Thus Combined margin emission factor is changed in section B.6.2, B.6.3 and Appendix 4 of PDD which is part of ex-ante calculation.
4. Mention of note in section B.6.3 stating that Auxiliary consumption and Transformation losses are assumed just for Net Electricity Generation estimation. In actual net electricity generation is monitored and it covers auxiliary consumption and transformation loss. Thus separate monitoring of Auxiliary consumption and Transformation losses is not required
5. The update in PDD as per new template requirements like section A.5 History of Project, section B.6.2 and B.7.1 Purpose of data - Section F Approval and Authorization

The revised PDD version 06 was approved by CDM Executive Board on dated 14/01/2021 vide PRC 4776-00.

B.2.3. Changes to the start date of the crediting period

The start date of the crediting period has been changed to 15/03/2013 to 14/03/2023 from 15/03/2012 to 14/03/2022⁴.

B.2.4. Inclusion of monitoring plan

There has not been any change in the monitoring plan during the current monitoring period.

B.2.5. Permanent changes to the registered monitoring plan, or permanent deviation of monitoring from the applied methodologies, standardized baselines, or other methodological regulatory documents

Following PRC change- Monitoring plan is envisaged:
There is difference in electricity mentioned in JMR and electricity mentioned in Invoice, thus transparent note is added to consider the Minimum of Net electricity supplied by the project activity to grid as per JMR (MWh) and Scheduled Energy as per Monthly Energy Account issued by

⁴ <https://cdm.unfccc.int/PRCContainer/DB/prcp749583822/view>

⁴ <https://cdm.unfccc.int/Projects/DB/BVQI1304680909-79/view>



UPSLDC (MWh) as a conservative approach. The revised PDD version 06 was approved by CDM Executive Board on dated 14/01/2021 vide PRC-4776-0015.

B.2.6. Changes to project design

There has not been any change in the PDD during the current monitoring period.

B.2.7. Changes specific to afforestation or reforestation project activity

This is not an afforestation or reforestation project activity.

SECTION C. Description of monitoring system

The project activity has four generators and individual total generation can be metered. The electricity is stepped up to 400 kV and individual four feeder lines have meters. There are two electricity lines each from Uttar Pradesh (UPPCL) and Uttarakhand state (PTCUL). The total electricity generation are measured at the power house/ control room. Auxiliary consumption and transformation loss can be calculated from the difference between total generation and net dispatch. The net dispatch to the grid metered by main dispatch meters are used for the calculation of emission reduction. This reading can also be cross checked with the documents of electricity supply (sale to UPPCL and free supply to Uttarakhand state).

The project activity is operated and managed by the project proponent. The hydro power project abides all regulatory and statutory requirements as prescribed under the state and central laws and regulations. A CDM project team is established at the plant site. The project team is entrusted with the responsibility of recording the electricity generated by the project activity which are measured from the meters installed at the plant site. The meters are calibrated and sealed before being installed. The project team is responsible for calculation of actual credible emission reduction in the most transparent and relevant manner. Installed meter/s used to measure the net electricity exported are calibrated annually.

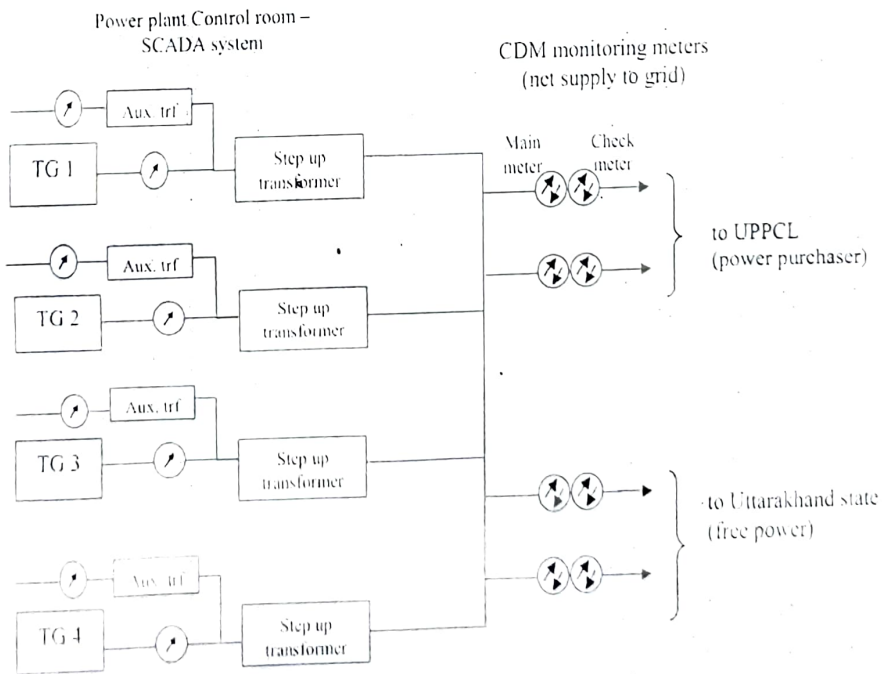

<https://cdm.unfccc.int/PRCContainer/DB/prcp749583822/view>

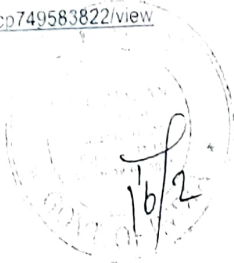

 Electricity Meter

All the monitoring data will be recorded and stored electronically (spread sheets) by the Project Executor and Controller at the plant site for a period of Crediting Period + 2 years. As the important data that needs to be measured are the quantity of electricity supplied by the project activity to the grid, there is no case of data uncertainties and the generation data can be cross-checked with the export details to the grid (available from power purchaser). Only three parameters need monitoring in the project activity. The electricity dispatch are measured by export meter and cross checked with a check meter. If any inconsistency observed in daily reading, the meters will be checked and replaced with pre-calibrated spare meter. The power sale invoice/ bills are used to correct the CDM monitoring requirements as that will be conservative (as approved by the power purchaser).

Designation	Responsibilities
Project Head	<ul style="list-style-type: none"> • Project Registration • Overall monitoring plan Execution with a special emphasis to the data archival
Project Executor and Controller plant site	<ul style="list-style-type: none"> • Operation • Verification of data • Inspection of data whenever necessary to independently check the authenticity of data and take corrective actions wherever required. • Storage of data • Monitoring of the data archiving
Site Main Controller	<ul style="list-style-type: none"> • Operation, Monitoring and Verification of Data • Data Recording • Storage of data • Data archiving
Operation and Maintenance Contractor	<ul style="list-style-type: none"> • Operation and Maintenance • Calibration of measuring equipments

Data archiving:

As data archival is an important component of the monitoring process in the CDM, the project proponent will take a special care for this process. The entire data that is monitored will be maintained in the electronic format and also in the Log books for a period of crediting period or last issuance whichever later + 2 years as required.

Data Uncertainty:

In case main electricity meter is reported for error more than $\pm 0.2\%$, the check meter reading will be used for the CER calculations and maximum error will be applied to the readings from last calibration or zero check of the main meter.



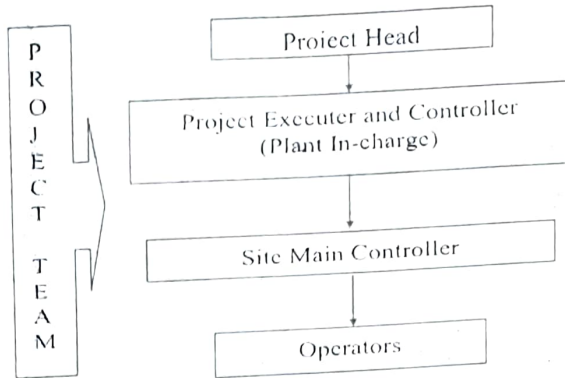

QA and QC:

As per clause 4.4 of the PPA, if during test checks, the main meters are not within permissible limits of error, but the check meters are within permissible limits of error, the check meters will be used for monitoring and main meters will be recalibrated. If during the test checks, both the main and check meter are found to have error beyond permissible, both the meters will be calibrated and calibration factor for the main meter will be applied to main meter readings for one month's readings for monitoring. If both the main meter and check meter fail to record, or if the power transformer fuses are blown out, the monitoring will be based on meter readings recorded by the main meter plus the Design Energy Pro-rata for the period excluding outages in the generation. No such events occurred during current monitoring period

The monitored net electricity export to the grid are cross checked with the payment receipts from the power purchaser and free electricity supplied to the state in those records.

SECTION D. Data and parameters

D.1. Data and parameters fixed ex ante

Data/Parameter	EF _{OM,y}
Unit	tCO ₂ /MWh
Description	The Operating Margin emission factor
Source of data	This is calculated as the weighted average of the recent 3 years (2005-06, 06-07, 07-08) OM data which is been provided by Central Electricity Authority (CO ₂ Baseline database for the Indian power sector, Version 4.0).
Value(s) applied	1.0084
Choice of data or measurement methods and procedures	The database is Government of India's official publication based on the 'Tool to calculate the emission factor for an electricity system'.
Purpose of data/parameter	This data item is required for estimating the baseline emissions and emission reductions.
Additional comments	The yearly Operating Margin emission factor of NEWNE grid is as follows 2005-06: 1.0195; 2006-07: 1.0083; 2007-08: 0.9992; Yearly Net Generation (GWh) in Operating Margin (GWh) as follows 2005-06: 359,270.98; 2006-07: 379,470.60; 2007-08: 401,641.59; 3 years generation weighted Average = 1.0084

Data/Parameter	EF _{OW,y}
Unit	tCO ₂ /MWh
Description	The Build Margin emission factor
Source of data	The OM data for NEWNE grid for 2007-08 which has been provided by Central Electricity Authority (CO ₂ Baseline database for the Indian power

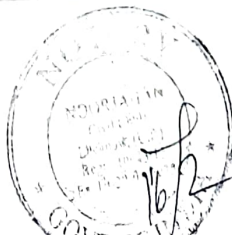

	sector, Version 4.0)
Value(s) applied	0.5977,
Choice of data or measurement methods and procedures	The database is Government of India's official publication based on the 'Tool to calculate the emission factor for an electricity system'.
Purpose of data/parameter	This data item is required for estimating the baseline emissions and emission reductions.
Additional comments	Latest available value used for year 2007-08

Data/Parameter	EF _{electricity}
Unit	tCO ₂ /MWh
Description	The Combined Margin Emission factor of the grid
Source of data	Calculated
Value(s) applied	0.8032
Choice of data or measurement methods and procedures	Calculated as the weighted average of the build margin emission factor and operating margin emission factor
Purpose of data/parameter	This data item is required for estimating the baseline emissions and emission reductions.
Additional comments	Ex-ante value will be used for the entire crediting period

Data/Parameter	EF _{Res}
Unit	kgCO ₂ e/MWh
Description	Default emission factor for emissions from reservoirs.
Source of data	The default value as per EB23 is 90 kgCO ₂ e/MWh.
Value(s) applied	90
Choice of data or measurement methods and procedures	The used is default emission factor suggested in the methodology applied.
Purpose of data/parameter	--
Additional comments	--

Data/Parameter	EF _{diesel,CO₂}
Unit	tCO ₂ /GJ
Description	CO ₂ emission factor of the diesel
Source of data	CEA CO ₂ Baseline Database for the India Power Sector, version 4.0
Value(s) applied	0.0726
Choice of data or measurement methods and procedures	The value is taken from the database developed by Central Electricity Authority (CO ₂ Baseline database for the Indian power sector, Version 4.0). The database is Government of India's official publication based on the 'Tool to calculate the emission factor for an electricity system'.
Purpose of data/parameter	--
Additional comments	CEA CO ₂ Baseline Database ⁶ , Assumptions sheet, Cell H7

Data/Parameter	ρ _{diesel}
Unit	kg/m ³
Description	Density of fossil fuel used in DG set for backup power (diesel)
Source of data	Specifications of diesel in country as per latest Bharat Stage IV/ Euro IV Vehicular Emissions Norms

⁶ http://www.cea.nic.in/planning/cf_20and%20e-Government%20of%20India%20website.htm

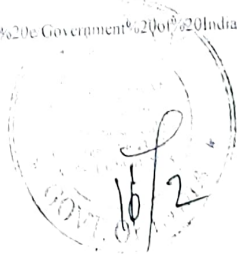

Value(s) applied	845.0
Choice of data or measurement methods and procedures	This is national level default (as part of fuel specifications) and PP is likely to use same quality fuel for the DG set
Purpose of data/parameter	--
Additional comments	--

D.2. Data and parameters monitored

Data/Parameter	EG _{facility y}
Unit	MWh
Description	The net electricity supplied by the project activity to grid
Measured/calculated/default	Measured
Source of data	Electricity supply to grid log book
Value(s) of monitored parameter	1,385,204
Monitoring equipment	Energy Meter For detailed schedule of calibration please refer Annexure 1
Measuring/reading/recording frequency	Hourly measurement and monthly recording
Calculation method (if applicable)	The electricity supplied by the project activity will be measured using electricity meter (3 phase 4 wire meter and of an accuracy of 0.2s) installed at the project site (switch yard/ site sub-station). The measurement also has a check meter installed and owned by the power purchaser. If during calibration, main meter is not within permissible $\pm 0.2\%$ error, then check meter will be used for the billing and monitoring. This form of measuring is in accordance with the best practices of the power industry in the host country. measurement equipment – electricity meter (on 400 kV side at project switch yard). Measurement process – electronic logging of the hourly meter reading Calibration procedure – National Test House or equivalent – third party Testing accuracy of the measurement - $\pm 0.2\%$ Responsible person for measurement – recording by electrical operator, daily log sheet to be signed by supervisor Measurement interval – continuous monitoring and monthly record
QA/QC procedures	The data will be used directly to calculate the emission reduction; hence the data will be checked for accuracy with the electricity supply invoice ⁷ obtained from the grid. The electricity reading will be taken by operator and monthly a joint meter reading or JMR will be signed by PP and power purchaser. This will be used to confirm the net electricity supplied to grid. The electricity meter will be calibrated annually.
Purpose of data/parameter	For Calculation of Baseline emissions
Additional comments	-

⁷ Note -The monthly tariff invoices are being raised based on the UPERC Generation Tariff Regulations in force. Invoices are being done for Energy Charges based on Schedule Generation certified by the UPSLDC for that month. The Invoices are based upon the scheduled energy and after deducting 12% of JMR electricity as free energy for Govt of Uttarakhand. There is difference between Scheduled Energy and Actual JMR Energy, hence for comparison purpose, Net Energy as per Invoice (KWh) is back calculated after adding 12% JMR to scheduled Energy and adding difference of scheduled Energy (no of units exported as per Monthly Energy Account issued by UPSLDC) and JMR Actual Energy. Finally Deviation Settlement Mechanism (DSM) statements settles out the difference between Scheduled and Actual Energy as per Electricity Board regulations. As a conservative approach, Minimum of Net electricity supplied by the project activity to grid as per JMR (MWh) and Scheduled Energy as per Monthly Energy Account issued by UPSLDC (MWh) is considered for ER calculations

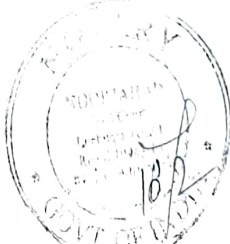

118)

CDM-MR-FORM

Data/Parameter	Cap _{PJ}
Unit	MW
Description	Installed capacity of the hydro power plant after the implementation of the project activity
Measured/calculated/default	Measured
Source of data	Approved project capacity as per the Techno-economic clearance for the CEA
Value(s) of monitored parameter	330 MW
Monitoring equipment	Energy Meter
Measuring/reading/recording frequency	Yearly – Electrical Head will ensure the measurement as per applicable standard
Calculation method (if applicable)	The project capacity will be monitored annually by a third party chartered engineer with test as per the appropriate National Standard of testing
QA/QC procedures	Yearly – Electrical Head will ensure the measurement as per applicable standard. This data will be used to confirm that power density of project is greater than minimum requirement specified by ACM0002. Power density of project always comes greater than 10 W/m ² even if calculated on conservative basis. hence no project emissions are applicable for project activity.
Purpose of data/parameter	For Calculation of Project emissions
Additional comments	Based on CEA TEC, 2000 – capacity is 4 turbines, 82.5 MW each. This matches with the actual turbine capacity - 82.5 x 4 No.

Data/Parameter	A
Unit	m ²
Description	Surface area of the pondage at the full volume
Measured/calculated/default	Measured
Source of data	Design data from the project report
Value(s) of monitored parameter	3,100,000
Monitoring equipment	Topographical survey
Measuring/reading/recording frequency	Yearly – civil head will ensure the measurement as per applicable standard.
Calculation method (if applicable)	The surface area is calculated using the design schematics. This form of measuring is in accordance with the best practices of the power industry in the host country
QA/QC procedures	The surface area of the pondage at full volume will be measured at project commissioning from a detailed topographical survey. This data will be used to confirm that the power density of the project is greater than the minimum requirement specified by the ACM0002. Power density of project always comes greater than 10 W/m ² even if calculated on conservative basis. hence no project emissions are applicable for project activity.
Purpose of data/parameter	For Calculation of Project emissions
Additional comments	The surface area measurement will also be done and certified by independent third party Certified Engineer.

Data/Parameter	FF _{1y}
Unit	ton
Description	Quantity of fuel type 1 combusted in the back up power plant (DG set)
Measured/calculated/default	Calculated

Handwritten signature: 16/2
Circular stamp: [Faint, illegible text]

default	
Source of data	The diesel inventory records at the plant will be used to calculate diesel consumption in DG set for backup power generation
Value(s) of monitored parameter	24.26
Monitoring equipment	Not Applicable
Measuring/reading/recording frequency	Continuously and Monthly Recording
Calculation method (if applicable)	Data type: Calculate Responsibility: Manager (Stores) along with the inventory staff Recording Frequency: Monthly Archiving procedure: Paper and Electronic Calibration Frequency: not required as purchase records/ inventory is used to calculate diesel consumption
QA/QC procedures	
Purpose of data/parameter	For Calculation of Project emissions
Additional comments	In case inventory records, supplier data is in volume terms, density will be used to get mass of the fuel consumed. Data archived will be kept 2 years beyond the Crediting period.

Data/Parameter	NCV _i ,y
Unit	GJ/Tonnes
Description	Weighted average net calorific value of fuel type Diesel
Measured/calculated/default	Default
Source of data	IPCC default value with upper limit of uncertainty at 95% confidence level. Considered IPCC default value as no value provided by the fuel suppliers in invoices.
Value(s) of monitored parameter	43.3
Monitoring equipment	
Measuring/reading/recording frequency	Monthly As per registered monitoring plan, The NCV will be obtained for each fuel delivery, from which weighted average annual values will be calculated, however fuel suppliers' Invoices do not mention calorific value, thus NCV is calculated based on CEA database and compared with IPCC default value with upper limit of uncertainty at 95% confidence level and higher value is considered for project emissions as a conservative approach.
Calculation method (if applicable)	Data type: Calculate Recording Frequency: monthly Archiving procedure: Paper and Electronic
QA/QC procedures	As per registered monitoring plan "Values of net calorific value obtained for each delivery will be counterchecked with IPCC default values as provided in the Table 1.2, Vol(2), Energy of the 2006 IPCC Guidelines on National GHG inventories to ensure the consistency" For current monitoring period, fuel suppliers' Invoices do not mention calorific value, thus NCV is calculated based on CEA database and compared with IPCC default value with upper limit of uncertainty at 95% confidence level and higher value is considered for project emissions as a conservative approach.
Purpose of data/parameter	For Calculation of Project emissions



Additional comments	In case supplier invoices has GCV record, NCV will be calculated using default delta conversion factors by CEA data ^a . Also, if the fuel suppliers' Invoices do not given calorific value record, the default of CEA database will be used for project emission calculations. Data archived will be kept 2 years beyond the Crediting period.
---------------------	---

D.3. Implementation of sampling plan
Not Applicable

SECTION E. Calculation of emission reductions or net anthropogenic removals

E.1. Calculation of baseline emissions or baseline net removals

Baseline emissions are calculated as the KWh produced by the renewable generating unit multiplied by an emission coefficient for the Northern region grid.

$$\begin{aligned}
 BE_y &= EG_{\text{facility},y} \cdot EF_{\text{electricity}} \\
 &= 1,385,204 \cdot 0.8032 \\
 &= 1,112,595 \text{ tCO}_2\text{e (Rounded down value)}
 \end{aligned}$$

Where,
 EG_y is the net quantity of electricity exported to the grid by the project in year y .
 CEF_{grid} is the carbon grid emissions factor of the Northern (now a part of NEWNE) region grid.

E.2. Calculation of project emissions or actual net removals

DG set on the site is used only as a back up to run the essential auxiliaries when the unit of power project is down. However, the same is considered under project emissions as per the following computation:

$$\begin{aligned}
 PE_{\text{CO}_2,y} &= FF_y \cdot COEF_{\text{CO}_2} \\
 PE_{\text{CO}_2,y} &= 24.26 \cdot 43.3 \cdot 0.0726 \\
 PE_{\text{CO}_2,y} &= 83 \text{ tCO}_2\text{e (Rounded up Value)}
 \end{aligned}$$

where:
 FF_y is the quantity of fossil fuel type used in the project during the year y , in tones and
 $COEF_{\text{CO}_2}$ is the CO_2 emission factor of the fossil fuel type in tCO_2/ton of fuel.
 $COEF_{\text{CO}_2} = NCV_{\text{FF}} \cdot EF_{\text{CO}_2}$

where
 NCV_{FF} is the net calorific value (energy content) per mass or volume unit of a fossil fuel.
 EF_{CO_2} is the carbon emission factor per unit of energy of the fossil fuel.

For new hydroelectric power projects with reservoirs, project proponents shall account for project emissions, estimated as follows:
 a) if the power density of project is greater than 4 W/m^2 and less than or equal to 10 W/m^2 :

$$PE_{\text{Res}} = \frac{EF_{\text{Res}} \cdot TEG_{\text{Res}}}{1000}$$

where,
 PE_{Res} is the Emission from reservoir expressed as $\text{tCO}_2\text{e/year}$
 ES_{Res} is the default emission factor for emissions from reservoirs, and the default value as per

^a As per CEA database Version 15 (http://www.cea.nic.in/reports/others/thermal/tncece/cdm_co2/user_guide_ver15.pdf), the GCV of Diesel comes out to be 10 500 Kcal/Kg which gives a value of 43 963.5 KJ/Kg, which is then converted to NCV by using default conversion factor 5% and gives a value of 41 765 GJ/Ton whereas in the project activity, IPCC 2006 default value with upper limit of uncertainty at 95% confidence level i.e. 43.3 GJ/Ton is used which is more conservative in nature.



(21)

EB23 is 90 kg CO₂e /MWh.

TEG_y is total electricity produced by the project activity, including the electricity supplied to the grid and the electricity supplied to internal loads, in year y (MWh).

The power density of project is calculated as below.

Parameter	Unit	Value
Installed Capacity	W	33,0000,000
Reservoir after project implementation	m ²	3,240,000
Power Density	W/ m²	101.85

As the power density of the pondage in the project activity is more than 10 W/m², this project emission need not be considered.

E.3. Calculation of leakage emissions

The main emissions potentially giving rise to leakage in the context of electric sector projects are emissions arising due to activities such as power plant construction, fuel handling (extraction, processing, and transport), and land inundation (for hydroelectric projects – see applicability conditions above).

As per the methodology, the leakage need not be considered. Thus, leakage is not considered in the project activity.

LE_y = 0

E.4. Calculation of emission reductions or net anthropogenic removals

	Baseline GHG emissions or baseline net GHG removals (t CO ₂ e)	Project GHG emissions or actual net GHG removals (t CO ₂ e)	Leakage GHG emissions (t CO ₂ e)	GHG emission reductions or net anthropogenic GHG removals (t CO ₂ e)			
				Before 01/01/ 2013	From 01/01/ 2013 until 31/12/ 2020	From 01/01/ 2021	Total amount
Total	1,112,595	83	0	0	1,112,512	0	1,112,512

E.5. Comparison of emission reductions or net anthropogenic removals achieved with estimates in the registered PDD

Amount achieved during this monitoring period (t CO ₂ e)	Amount estimated ex ante for this monitoring period in the PDD (t CO ₂ e)
1,112,512	1,104,935

E.5.1. Explanation of calculation of "amount estimated ex ante for this monitoring period in the PDD"

As per CDM registered PDD, 1,203,884 tCO₂e is the amount of CERs generated annually. Therefore, following unitary method, the amount of estimated ex ante for this monitoring period is identified. The total number of days in this monitoring period is 434.

$$= (1,203,884/365) * 335$$

$$= 1,104,935 \text{ tCO}_2\text{e}$$



E.6. Remarks on increase in achieved emission reductions

During the present monitoring period, actual emission reductions achieved are 1% higher than the estimated emission reductions.

The difference in emission reduction as above may be attributed to the uncertain nature of water availability to the project activity. The electricity generation by the project activity depends upon the water availability at the project site which depends upon the annual rainfall in the region. Thus it is nature dependent and not in control of PP.

E.7. Remarks on scale of small-scale project activity

This Project activity is not a small project activity.



Document information

Version	Date	Description
08.0	6 April 2021	Revision to: <ul style="list-style-type: none"> Reflect the "Clarification: Regulatory requirements under temporary measures for post-2020 cases" (CDM-EB109-A01-CLAR).
07.0	31 May 2019	Revision to: <ul style="list-style-type: none"> Ensure consistency with version 02.0 of the "CDM project standard for project activities" (CDM-EB93-A04-STAN); Add a section on remarks on the observance of the scale limit of small-scale project activity during the crediting period; Add "changes specific to afforestation or reforestation project activity" as a possible post-registration changes; Clarify the reporting of net anthropogenic GHG removals for A/R project activities between two commitment periods; Make editorial improvements.
06.0	7 June 2017	Revision to: <ul style="list-style-type: none"> Ensure consistency with version 01.0 of the "CDM project standard for project activities" (CDM-EB93-A04-STAN); Make editorial improvements.
05.1	4 May 2015	Editorial revision to correct version numbering.
05.0	1 April 2015	Revisions to: <ul style="list-style-type: none"> Include provisions related to delayed submission of a monitoring plan; Provisions related to the Host Party; Remove reference to programme of activities; Overall editorial improvement.
04.0	25 June 2014	Revisions to: <ul style="list-style-type: none"> Include the Attachment: Instructions for filling out the monitoring report form (these instructions supersede the "Guideline: Completing the monitoring report form" (Version 04.0)); Include provisions related to standardized baselines; Add contact information on a responsible person(s)/ entity(ies) for completing the CDM-MR-FORM in A.6 and Appendix 1; Change the reference number from F-CDM-MR to CDM-MR-FORM; Editorial improvement.
03.2	5 November 2013	Editorial revision to correct table in page 1.
03.1	2 January 2013	Editorial revision to correct table in section E.5.



(29)

CDM-MR-FORM

Version	Date	Description
03.0	3 December 2012	Revision required to introduce a provision on reporting actual emission reductions or net GHG removals by sinks for the period up to 31 December 2012 and the period from 1 January 2013 onwards (EB 70, Annex 11).
02.0	13 March 2012	Revision required to ensure consistency with the "Guidelines for completing the monitoring report form" (EB 66, Annex 20).
01.0	28 May 2010	EB 54, Annex 34. Initial adoption.

Decision Class: Regulatory
Document Type: Form
Business Function: Issuance
Keywords: monitoring report

4/16/22

RL

ID of Deponed



भारत सरकार
 Government of India

 रामा शंकर अवरथी
 Rama Shanker Awasthi
 जन्म तिथि / DOB 07/04/1973
 पुरुष / Male



9025 6352 1781



मेरा आधार, मेरी पहचान

भारतीय विशिष्ट पहचान प्राधिकरण
 Unique Identification Authority of India

पता:
 आत्मनज, गया प्रसाद अवरथी, 301,
 सुरभि डीलक्स अपार्टमेंट, 6/7,
 डालिबाग, लखनऊ, लखनऊ जी.पी.
 उत्तर प्रदेश, 226001

Address:
 S/O. Gaya Prasad Awasthi, 301,
 Surabhi Deluxe Apartment, 6/7
 Dalibagh, Lucknow, Lucknow G.P.
 Uttar Pradesh, 226001

9025 6352 1781

1947 help@uidai.gov.in www.uidai.gov.in

R. Anand

